

Portable Compact Disc Player

Service Service Service

AX3300 AX3301 AX3303
AX3305 AX3306 AX3311
AX3312 AX3315
all versions



PRODUCT FAMILY 2004 – CDDA 3 SERIES

Service Manual



TABLE OF CONTENTS

Technical specification	1-1
Features and Accessories	1-2
Connections and controls	1-3
Instruction for use	1-4..1-6
Safety & Warnings	1-7
Handling chip components	1-8
Service tools	1-8
Service hints	
Repair positions	2-1
Dismantling CD-door	2-1
Start-up procedure	3-1
Service Test Program	3-2..3-3
Blockdiagram	3-4

Circuit diagrams

Control/support part	4-1
Audio part	4-2
Drive/ESP part	4-3

Layout diagrams

Componentside view	4-4
Copperside view	4-5
Exploded view	5-1
Mechanical partslist	5-1
Electrical partslist	6-1

© Copyright 2003 Philips Consumer Electronics B.V. Eindhoven, The Netherlands
All rights reserved. No part of this publication may be reproduced, stored in a retrieval
system or transmitted, in any form or by any means, electronic, mechanical, photocopying,
or otherwise without the prior permission of Philips.

Published by LX 0406 Service Audio Printed in The Netherlands Subject to modification

GB 3140 785 32890

Version 1.0



PHILIPS

**CLASS 1
LASER PRODUCT**

TECHNICAL SPECIFICATION

General

Dimensions (HxD)	:23.3x137.5 mm
Weight without batteries	:187g

Power supply modes

DC-in socket	: 2.5 - 6.0V
Primary batteries (2xLR6)	: 2.0 - 3.6V
Rechargeable batteries	: 2.0 - 3.6V

Battery lifetime

BATTERY TYPE	ESP=ON	PSM
Primary Batteries 2 x LR6	≥ 12h (15h typ.)	≥ 18h (20h typ.)
Primary Batteries 2 x AAA	Tbd	≥ 7 h (9h typ.)
Rechargeable Batteries AY3363	Tbd	≥ 4h (6h typ.)

Battery level detection

DETECTION LEVEL	Vbatt. Alkaline	Vbatt. NMH
Battery empty	1.8V +100/-50mV	1.8V +100/-50mV
Battery weak 1	battery empty level + 0.75V ±100mV	battery empty level + 0.5V ±100mV
Battery weak 2	battery empty level + 0.50V ±100mV	battery empty level + 0.45V ±100mV
Battery weak 3	battery empty level + 0.3V ±100mV	battery empty level + 0.3V ±100mV

Current consumption CDDA-playback

OPERATION MODE	DC-IN SUPPLY (4.5V)		BATT. SUPPLY (2.25V)	
	Powersave	ESP=ON	Powersave	ESP=ON
Play-mode	90mA typ.	100mA typ.	100mA typ.	120mA typ.
Charge-mode	160mA typ.		n/a	n/a
Jump-mode	220mA typ.		300mA typ.	400mA typ.
Stand-by	30 mA typ.		350µA typ.	

Shock resistance

+X/-X direction	: ≥2.5 g
+Y/-Y direction	: ≥2.5 g
+Z/-Z direction	: ≥2 g

Headphone out (measured with 16Ω load, DBB/ESP off)

Output power (THD=10%)	
/17 version only	: 2x3mW (+1/-3dB)
all other versions	: 2x3.5mW (+2/-2dB)
Frequency response (1mW)	: 100Hz-20kHz within 6dB
S/N ratio (unwght)	: ≥100dB
S/N ratio (A-wght)	: ≥75dB (80dB typ.)
THD+N (1kHz, 1mW)	: ≤1% (0.2% typ.)
Channel crosstalk (1kHz, w/o load)	: ≤-24dB (-58dB typ.)
Channel unbalance (-40dB)	: ≤5dB
Volume attenuation (1kHz)	: >60dB

Dynamic Bass Boost DBB

DBB STAGE	Frequency response		
	63Hz	1kHz	10kHz
DBB1	+9dB ± 2dB	0.3dB ± 2dB	-1dB ± 2dB

Measurement setupCD

Use Audio Signal disc SBC429

4822 397 30184

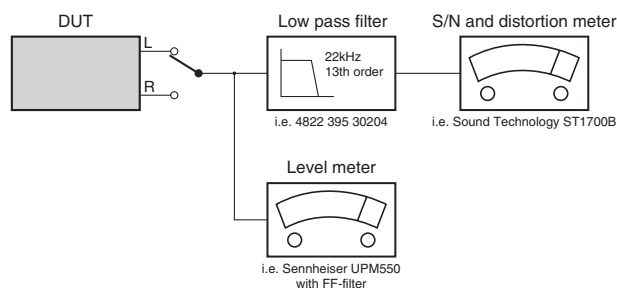

FEATURES

FEATURES OF CD-PORTABLE	AX3300/10	AX3301/00C	AX3301/00Z	AX3301/05Z	AX3301/01	AX3303/00C	AX3303/05Z	AX3305/01	AX3306/10	AX3311/17	AX3312/17	AX3315/17
CD-RW COMPATIBILITY	●	●	●	●	●	●	●	●	●	●	●	●
ELECTRONIC SKIP PROTECTION	45s	45s	45s	45s	45s	45s	45s	45s	45s	45s	45s	45s
ESP DRAM SIZE [Mbit]	16	16	16	16	16	16	16	16	16	16	16	16
HOLD / RESUME FUNCTION	●/●	●/●	●/●	●/●	●/●	●/●	●/●	●/●	●/●	●/●	●/●	●/●
DBB STAGES	1	1	1	1	1	1	1	1	1	1	1	1
ACOUSTIC FEEDBACK	--	--	--	--	--	--	--	--	--	--	--	--
PROGRAM MEMORY	30	30	30	30	30	30	30	30	30	30	30	30
RECHARGE NiCd / NiMH	--/--	--/--	--/--	--/--	--/--	--/●	--/●	--/--	--/--	--/--	--/--	--/--
BELT-CLIP	--	--	--	--	--	--	--	--	--	--	--	--
CORD REMOTE CONTROL	--	--	--	--	--	--	--	--	--	--	--	--
LINE / OPT. DIGITAL OUTPUT	--/--	--/--	--/--	--/--	--/--	--/--	--/--	--/--	--/--	--/--	--/--	--/--

ACCESSORIES

ACCESSORIES FOR CD-PORTABLE		AX3300					AX3303			AX3305				AX3306			AX3311		AX3312		AX3315	
		/10	/00C	/00Z	/05Z	/01	/00C	/05Z	/01				/10	/17	/17	/17	/17					
AY3170/00 AC/DC Adaptor	3140 118 31923	X	X				X															
AY3170/02 AC/DC Adaptor	3140 118 32024				X			X														
AY3170/05 AC/DC Adaptor	3140 118 33611			X			X															
AY3170/10 AC/DC Adaptor	3140 118 32182											X										
AY3501/00 Car Cassette Adaptor	3140 118 71842							X	X													
AY3548/00 Car DC/DC Adaptor	3140 118 71901							X	X													
AY3363 Battery-NIMH-AAA	3103 308 84542						X	X														
AY3363 Battery-NIMH-AAA-BYD	3103 308 84721						X	X														
Door-Battery-2A	3140 117 72151	X	X	X	X	X	X	X	X			X										
Door-Battery-3A	3140 117 71631												X	X	X							
HE225/77 Headphone	9082 100 02542	X	X	X	X	X	X	X	X			X										
HS383/77I Headphone	9082 100 02544												X		X							
HS383/77J Headphone	9082 100 02545														X							

X...supplied with the set

CONNECTIONS AND CONTROLS

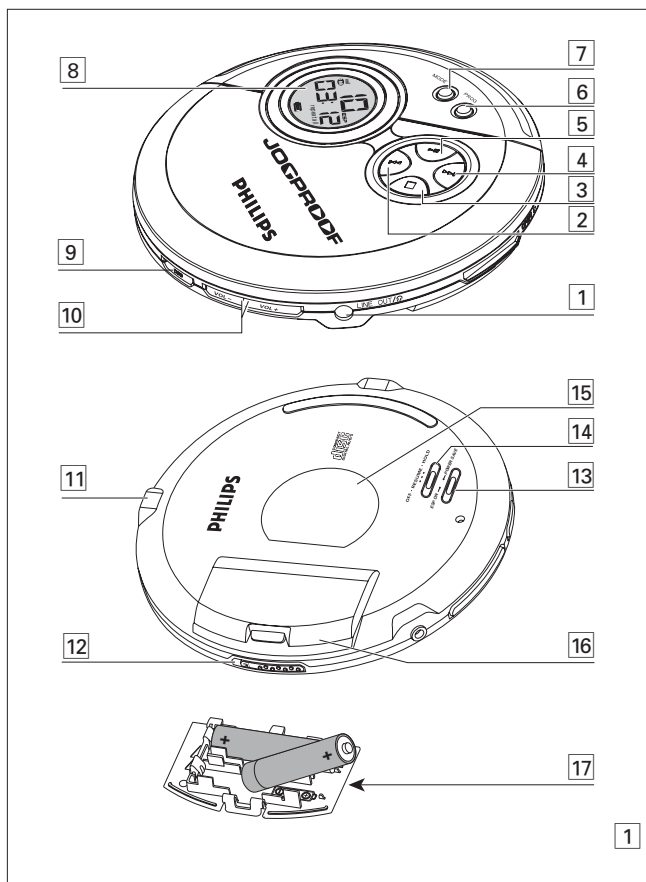

English

CONTROLS / POWER SUPPLY

Controls (see figure 1)

- 1 LINE OUT/⌚.....3.5 mm headphone socket, socket to connect the player to another audio input of an additional appliance
- 2 ⏮.....skips and searches CD tracks backwards
- 3 ■.....stops CD play, clears a program or switches the player off
- 4 ⏭.....skips and searches CD tracks forwards
- 5 ▶||.....switches the player on, starts or pauses CD play
- 6 PROG.....programs tracks and reviews the program
- 7 MODE.....selects the different playing possibilities: **shuffle**, **shuffle repeat all**, **repeat**, **repeat all** and **SCAN**
- 8display
- 9 DBB.....switches the bass enhancement on and off. This button also switches acoustic feedback (the beep) on/off when it is pressed for more than 2 seconds
- 10 VOL -/+.....adjusts the volume
- 11 4.5V DC.....socket for external power supply
- 12 OPEN ▶.....opens the CD lid
- 13 ESP ON / POWER SAVE.....to select between the battery powersave mode and **Electronic Skip Protection (ESP)**. ESP ensures continuous CD playback regardless of vibrations and shocks
- 14 OFF.....switches RESUME and HOLD off
RESUME.....stores the last position of a CD track played
HOLD.....locks all buttons
- 15typeplate
- 16battery compartment
- 17AAA battery door

This set complies with the radio interference requirements of the European Union.

QUICK START

MISE EN SERVICE RAPIDE

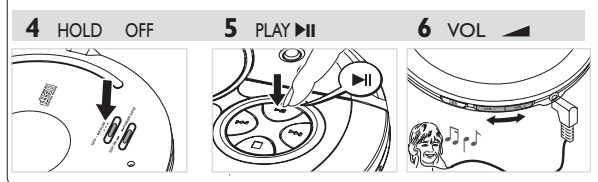
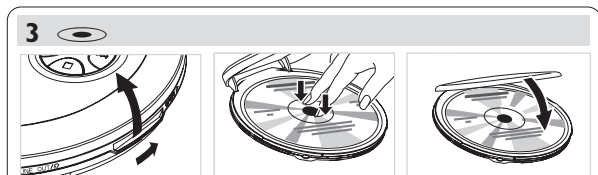
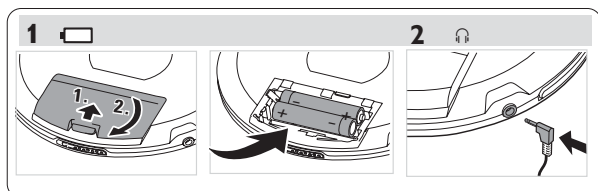

Batteries (supplied or optionally available)

For convenience, this model is designed with 2 different detachable battery doors. This allows you to operate the player using 2 choices of battery size. You can use the following batteries with this CD-player:

- alkaline batteries type **AAA (LR03, UM4)** or **AA (LR6, UM3)** preferably Philips.

Notes:— Old and new or different types of batteries should not be combined.
— Remove batteries if they are empty or if the player is not going to be used for a long time.

Inserting AAA (LR03, UM4) or AY 3363 batteries

- 1 Open the **AAA** battery door.
- 2 Insert **AAA** batteries as shown onto the back of the door.
- 3 Replace the battery-loaded **AAA** door back onto the set.

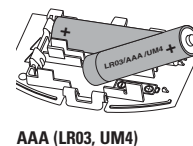

AAA (LR03, UM4)

Inserting AA (LR6, UM3) batteries

To double playback time, insert **AA** batteries into the battery compartment and use the **AA** marked battery door.

- Open the battery compartment and insert either 2 normal or alkaline batteries.

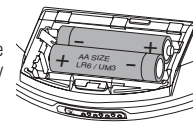

AA (LR6, UM3)

Battery indication

The approximate power level of your batteries is shown in the display.

- ▬ Battery full
- ▬ Battery two-thirds full
- ▬ Battery one-third full
- ⏻ Battery dead or empty. When the batteries are dead or empty, the symbol  flashes, **bAtEt** is displayed, and the beep tone sounds repeatedly.



INSTRUCTION FOR USE

POWER SUPPLY / GENERAL INFORMATION

Average playing time of batteries under normal conditions

Battery type	ESP on	Power Save
Alkaline AA	15 hours	20 hours
Alkaline AAA	7 hours	9 hours
Rechargeable ECO-PLUS NiMH battery	3 hours	5 hours

Batteries contain chemical substances, so they should be disposed of properly.

ECO-PLUS NiMH battery information (for versions supplied with the rechargeable ECO-PLUS NiMH battery AY 3363)

Recharging works only on players supplied with the rechargeable ECO-PLUS NiMH battery AY 3363.

Recharging the ECO-PLUS NiMH battery on board

1 Insert the rechargeable ECO-PLUS NiMH battery AY 3363.

2 Connect the mains adapter to the 4.5V DC socket of the player and then to the wall socket.

→  is pulsing.

• Recharging stops after a maximum of 7 hours, or when you start playback.

3 When the battery is fully recharged, *FULL* appears in the display.



Notes:

- It is normal for the batteries to become warm during recharging.
- If the batteries become too warm, recharging will be interrupted for approximately 30 minutes.
- To ensure proper recharging on board, take care that contacts are clean.
- Use only the ECO-PLUS NiMH battery AY 3363.

Handling instructions

- Recharging already charged or half-charged batteries will shorten their lifetime. We therefore recommend that you let the rechargeable ECO-PLUS NiMH battery run till it is completely empty before you recharge it.
- To avoid a short circuit, do not let the battery touch any metal object.
- If the battery becomes empty soon after recharging, then either its contacts are dirty or it has reached the end of its lifetime.

Mains adapter (supplied or optionally available)

Use only the AY 3170 adapter (4.5 V / 300 mA direct current, positive pole to the center pin). Any other product may damage the player.

1 Make sure the local voltage corresponds to the power adapter's voltage.

2 Connect the power adapter to the 4.5V DC socket of the player and to the wall socket.

Note: Always disconnect the adapter when you are not using it.

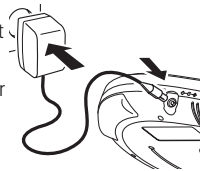

Environmental information

- All redundant packing material has been omitted. We have done our utmost to make the packaging easily separable into two mono materials: cardboard (box) and polyethylene (bags, protective foam sheet).
- Your set consists of materials which can be recycled if disassembled by a specialized company. Please observe the local regulations regarding the disposal of packing materials, exhausted batteries and old equipment.

GENERAL INFORMATION

CD player and CD handling

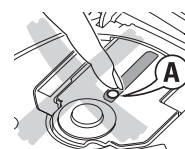
- Do not touch the lens **A** of the CD player.
- Do not expose the unit, batteries or CDs to humidity, rain, sand or excessive heat (caused by heating equipment or direct sunlight).
- You can clean the CD player with a soft, slightly dampened, lint-free cloth. Do not use any cleaning agents as they may have a corrosive effect.
- To clean the CD, wipe it in a straight line from the center toward the edge using a soft, lint-free cloth. A cleaning agent may damage the disc! Never write on a CD or attach a sticker to it.
- The lens may cloud over when the unit is moved suddenly from cold to warm surroundings. Playing a CD is not possible then. Leave the CD player in a warm environment until the moisture has evaporated.
- Active mobile phones in the vicinity of the CD player may cause malfunctions.
- Avoid dropping the unit as this may cause damage.

Headphones HE225

- Connect the supplied headphones to the LINE OUT/🔊 socket of the player.

Note: LINE OUT/🔊 can also be used for connecting this set to your HiFi system. To adjust the sound and volume, use the controls on the connected audio equipment and on the CD player.

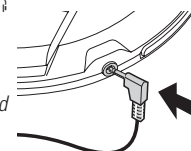
IMPORTANT!

Hearing safety: Do not play your headphones at a high volume. Hearing experts advise that continuous use at high volume can permanently damage your hearing.

Traffic safety: Do not use headphones while driving a vehicle. It may create a hazard and it is illegal in many countries. Even if your headphones are an open-air type designed to let you hear outside sounds, do not turn up the volume so high that you cannot hear what is going on around you.

In-car use (connections supplied or optionally available)

Only use the AY 3545 or AY 3548 car voltage converter (4.5 V DC, positive pole to the centre pin) and the AY 3501 car cassette adapter. Any other product may damage the set.

1 Put the set on a horizontal, vibration-free and stable surface. Make sure it is in a safe place, where the set is neither a danger nor an obstacle to the driver and the passengers.

2 Plug the voltage converter into the cigarette lighter socket (**only for 12 V car battery, negative grounding**), then connect the wired end with 4.5V DC input socket on the set.

3 If necessary, clean the cigarette lighter socket to obtain a good electrical contact.

4 Turn down the volume and connect the cassette adapter plug to LINE OUT/🔊 on the set.

5 Carefully insert the cassette adapter into the car radio's cassette compartment.

6 Make sure the cord does not hinder your driving.

7 Decrease the volume on the set if necessary. Start playback on the set and adjust the sound with the car radio controls.

- **Always remove the voltage converter from the cigarette lighter socket when the set is not in use.**

Note: If your car radio has a LINE IN socket, it is better to use it for the car radio connection instead of the adapter cassette. Connect the signal lead to this LINE IN socket and to LINE OUT/🔊 on the set.

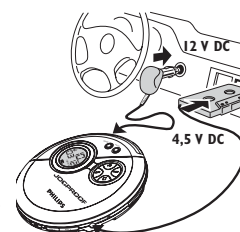

INSTRUCTION FOR USE

CD PLAY

Playing a CD

This CD-player can play all kinds of **Audio Discs** such as CD-Recordables and CD-Rewritables. Do not try to play a CD-ROM, CDi, VCD, DVD, MP3-CD or computer CD.

- 1 Push the OPEN ► slider to open the player.
- 2 Insert an audio CD, printed side up, by pressing the CD onto the hub.
- 3 Close the player by pressing the lid down.
- 4 Press ► to switch the player on and start playback.
 - The current track number and elapsed playing time are displayed.
- You can pause playback by pressing ►.
 - The time at which playback was paused starts flashing.
- You can continue playback by pressing ► again.
- 5 Press ■ to stop playback.
 - The total number of tracks and the total playing time of the CD are displayed.
- 6 Press ■ again to switch the player off.
- To remove the CD, hold it by its edge and press the hub gently while lifting the CD.

Note: If there is no activity, the set will automatically switch off after a while to save energy.

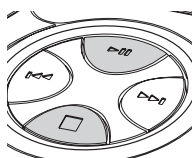
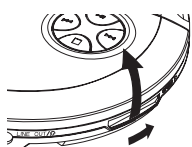

FEATURES

Selecting a track and searching

Selecting a track during playback

- Briefly press ◀ or ▶ once or several times to skip to the current, previous or next track.
 - Playback continues with the selected track, and the track's number is displayed.

Selecting a track when playback is stopped

- 1 Briefly press ◀ or ▶ once or several times to select the desired track. The track number is displayed.
- 2 Press ► to start CD play.
 - Playback starts with the selected track.

Searching for a passage during playback

- 1 Keep ◀ or ▶ pressed to find a particular passage in a backward or forward direction.
 - Searching starts while playback continues at low volume. After 2 seconds the search speeds up.
- 2 Release the button when you reach the desired passage.
 - Playback continues from this position.

Notes: – If the player is in SCAN mode (see MODE chapter), searching is not possible.

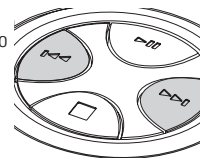

Playback information

- If a CD-Recordable (CD-R) or a CD-Rewritable (CD-RW) is not recorded properly, **RF d 15C** is displayed, indicating that the CD has not been finalized. In that case, use FINALIZE on your CD recorder to complete the recording.
- When playing a CD-Rewritable (CD-RW), please note that it takes 3–15 seconds after pressing ► for sound reproduction to start.
- Playback will stop if you open the CD lid.
- While the CD is read, **---** flashes in the display.



Volume and bass

Volume adjustment

- Adjust the volume by using VOL –/+ on the CD player or the slider on your remote control.

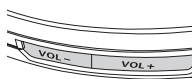

Bass adjustment

- Press DBB to switch the bass enhancement on or off.
 - **DBB** is shown if the bass enhancement is activated.

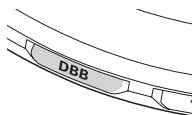

Programming track numbers

You can store up to 30 tracks to play in a program. A single track may be stored more than once in the program.

- 1 While playback is stopped, select a track with ◀ or ▶.
- 2 Press PROG to store the track.
 - **program** lights up; the track number programmed and **P** with the total number of stored tracks are displayed.
- 3 Select and store all desired tracks in this way.
- 4 Press ► to start playback of your selected tracks.
 - **program** is shown and playback starts.

- You can review the program by pressing PROG for more than 2 seconds. The display shows all the stored tracks in sequence.
 - Display **---** if no tracks programmed.

Notes: – If you press PROG and there is no track selected or no tracks programmed, **SEL** or **---** is displayed.
– If you try to store more than 30 tracks, **FULL** is displayed.

Clearing the program

- While playback is stopped, press ■ to clear program.
 - **CLF** is displayed once, **program** goes off, and the program is cleared.

Note: The program will also be cleared if the power supply is interrupted, or if the CD-player lid is opened, or if the set switches off automatically.

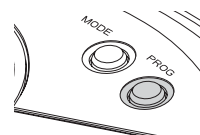

INSTRUCTION FOR USE

FEATURES

Selecting different playing possibilities MODE

It is possible to play tracks in random order, to repeat a single track or the entire CD, and to play the first few seconds of each track.

- Press MODE during playback as often as required in order to activate one of the following 'modes'. The active mode is shown in the display.
 - **shuffle**: All tracks of the CD are played in random order until all of them have been played once.
 - **shuffle repeat all**: All tracks of the CD are played repeatedly in random order.
 - **repeat**: The current track is played repeatedly.
 - **repeat all**: The entire CD is played repeatedly.
 - **SKIP**: The first 10 seconds of each of the remaining tracks are played in sequence.

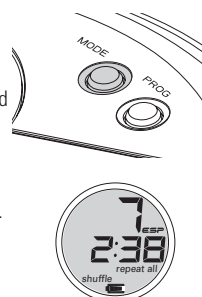

- Playback starts in the chosen mode after 2 seconds.
 - To return to normal playback, press MODE repeatedly until the display shows no active modes.

ESP / Power Save Mode

With a conventional portable CD-player you might have experienced that the music stopped e.g. when you were jogging. The **ELECTRONIC SKIP PROTECTION** prevents loss of sound caused by light vibrations and shocks. Continuous playback is ensured. However ESP does not prevent playback interruptions during vigorous running. It also does not protect the unit against any **damage** caused by **dropping!**

- Switch the slider to ESP ON during playback to activate the shock protection.
 - **ESP** is shown and the protection is activated.
- To deactivate the shock protection and enter the power save mode, switch the slider to POWER SAVE.
 - **ESP** goes off.

RESUME and HOLD

You can interrupt playback and continue (even after an extended period of time) from the position where playback stopped (RESUME) and you can lock all buttons of the set so that no action will be executed (HOLD). Use the OFF-RESUME-HOLD slider for these functions.

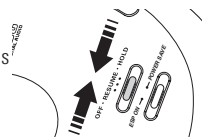

RESUME – continuing from where you have stopped

- Switch the slider to RESUME during playback to activate RESUME.
 - **resume** is shown.
- Press **■** whenever you want to stop playback.
- Press **▶||** whenever you want to resume playback.
 - **resume** is shown and playback continues from where you have stopped.



- To deactivate RESUME, switch the slider to OFF.
 - **resume** goes off.

HOLD – locking all buttons

You can lock the buttons of the set by switching the slider to HOLD. Now, when a key is pressed, no action will be executed. This is of use, for example, when transporting the player in a bag. With HOLD activated, you can avoid accidental activation of other functions.

- Switch the slider to HOLD to activate HOLD.
 - All buttons are locked **HOLD** is shown when you press any button. If the set is switched off, **HOLD** will be shown only when **▶||** is pressed.



- To deactivate HOLD, switch the slider to OFF.

Note: If you deactivate HOLD by switching the slider to RESUME, you will be activating the RESUME function.

TROUBLESHOOTING

Troubleshooting

WARNING: Under no circumstances should you try to repair the set yourself as this will invalidate the warranty. If a fault occurs, first check the points listed, before taking the unit for repair. If you are unable to solve a problem by following these hints, consult your dealer or service center.

The CD player has no power, or playback does not start

- Check that your batteries are not dead or empty, that they are inserted correctly, that the contact pins are clean.
- Your adapter connection may be loose. Connect it securely.
- For in-car use, check that the car ignition is on. Also check player's batteries.

The indication **NO CD** is displayed

- Check that the CD is clean and correctly inserted (label-side upward).
- If your lens has steamed up, wait a few minutes for this to clear.

The indication **RF CD** is displayed

- CD-RW (CD-R) was not recorded properly. Use FINALIZE on your CD-recorder.

The indication **HOLD** is on and/or there is no reaction to controls

- If HOLD is activated, then deactivate it.
- Electrostatic discharge. Disconnect power or remove batteries for a few seconds.

The CD skips tracks

- The CD is damaged or dirty. Replace or clean the CD.
- resume, shuffle or program is active. Switch off whichever is on.

Troubleshooting

No sound or bad sound quality.

- PAUSE might be active. Press **▶||**.
- Loose, wrong or dirty connections. Check and clean connections.
- Volume might not be appropriately adjusted. Adjust the volume on the CD player or slider on your remote control.
- Strong magnetic fields. Check player's position and connections. Also keep away from active mobile phones.
- For in-car use, check that the cassette adapter is inserted correctly, that the car cassette player's playback direction is correct (press autoreverse to change), and that the cigarette lighter jack is clean. Allow time for temperature change.

CAUTION

Use of controls or adjustments or performance of procedures other than herein may result in hazardous radiation exposure or other unsafe operation.

SAFETY & WARNINGS

Ⓒ **WARNING**

All ICs and many other semiconductors are susceptible to electrostatic discharges (ESD). Careless handling during repair can reduce life drastically. When repairing, make sure that you are connected with the same potential as the mass of the set via a wristband with resistance. Keep components and tools at this potential.

Ⓕ **ATTENTION**

Tous les IC et beaucoup d'autres semi-conducteurs sont sensibles aux décharges statiques (ESD). Leur longévité pourrait être considérablement écourtée par le fait qu'aucune précaution n'est prise à leur manipulation. Lors de réparations, s'assurer de bien être relié au même potentiel que la masse de l'appareil et enfilez le bracelet seri d'une résistance de sécurité. Veiller à ce que les composants ainsi que les outils que l'on utilise soient également à ce potentiel.

ESD



Ⓓ **WARNUNG**

Alle ICs und viele andere Halbleiter sind empfindlich gegenüber elektrostatischen Entladungen (ESD). Unvorsichtige Behandlung im Reparaturfall kann die Lebensdauer drastisch reduzieren. Sorgen Sie dafür, daß Sie im Reparaturfall über ein Pulsarmband mit Widerstand mit dem Massepotential des Gerätes verbunden sind. Halten Sie Bauteile und Hilfsmittel ebenfalls auf diesem Potential.

Ⓖ **WAARSCHUWING**

Alle IC's en vele andere halfgeleiders zijn gevoelig voor electrostatische ontladingen (ESD). Onzorgvuldig behandelen tijdens reparatie kan de levensduur drastisch doen verminderen. Zorg ervoor dat u tijdens reparatie via een polsband met weerstand verbonden bent met hetzelfde potentiaal als de massa van het apparaat. Houd componenten en hulpmiddelen ook op hetzelfde potentiaal.

Ⓘ **AVVERTIMENTO**

Tutti IC e parecchi semi-conduttori sono sensibili alle scariche statiche (ESD). La loro longevità potrebbe essere fortemente ridotta in caso di non osservazione della più grande cauzione alla loro manipolazione. Durante le riparazioni occorre quindi essere collegato allo stesso potenziale che quello della massa dell'apparecchio tramite un braccialetto a resistenza. Assicurarsi che i componenti e anche gli utensili con quali si lavora siano anche a questo potenziale.

Ⓒ **AVAILABLE ESD PROTECTION EQUIPMENT :**

anti-static table mat	large 1200x650x1.25mm	4822 466 10953
	small 600x650x1.25mm	4822 466 10958
anti-static wristband		4822 395 10223
connection box	(3 press stud connections, 1MΩ)	4822 320 11307
extendible cable	(2m, 2MΩ, to connect wristband to connection box)	4822 320 11305
connecting cable	(3m, 2MΩ, to connect table mat to connection box)	4822 320 11306
earth cable	(1MΩ, to connect any product to mat or to connection box)	4822 320 11308
KIT ESD3	(combining all 6 prior products - small table mat)	4822 310 10671
wristband tester		4822 344 13999

Ⓒ

Safety regulations require that the set be restored to its original condition and that parts which are identical with those specified be used. Safety components are marked by the symbol

Ⓕ

Les normes de sécurité exigent que l'appareil soit remis à l'état d'origine et que soient utilisées les pièces de rechange identiques à celles spécifiées. Les composants de sécurité sont marqués

SAFETY



Ⓓ

Bei jeder Reparatur sind die geltenden Sicherheitsvorschriften zu beachten. Der Originalzustand des Gerätes darf nicht verändert werden. Für Reparaturen sind Originalersatzteile zu verwenden. Sicherheitsbauteile sind durch das Symbol

Ⓖ

Veiligheidsbepalingen vereisen, dat het apparaat in zijn oorspronkelijke toestand wordt teruggebracht en dat onderdelen, identiek aan de gespecificeerde, worden toegepast. De Veiligheidsonderdelen zijn aangeduid met het symbool

Ⓘ

Le norme di sicurezza estigono che l'apparecchio venga rimesso nelle condizioni originali e che siano utilizzati i pezzi di ricambio identici a quelli specificati. Componenti di sicurezza sono marcati con

Ⓒ **DANGER:** Invisible laser radiation when open. AVOID DIRECT EXPOSURE TO BEAM.



Ⓔ **Varning !**

Osynlig laserstrålning när apparaten är öppnad och spärren är urkopplad. Betrakta ej strålen.

Ⓓ **Advarsel !**

Usynlig laserstrålning ved åbning når sikkerhedsafbrydere er ude af funktion. Undgå udsættelse for stråling.

Ⓕ **Varoitus !**

Avatussa laitteessa ja suojalukituksen ohitettaessa olet alttiina näkymättömälle laserisäteilylle. Älä katso säteeseen !

Ⓒ

After servicing and before returning the set to customer perform a leakage current measurement test from all exposed metal parts to earth ground, to assure no shock hazard exists. The leakage current must not exceed 0.5mA.

Ⓕ

"Pour votre sécurité, ces documents doivent être utilisés par des spécialistes agréés, seuls habilités à réparer votre appareil en panne".

HANDLING CHIP COMPONENTS

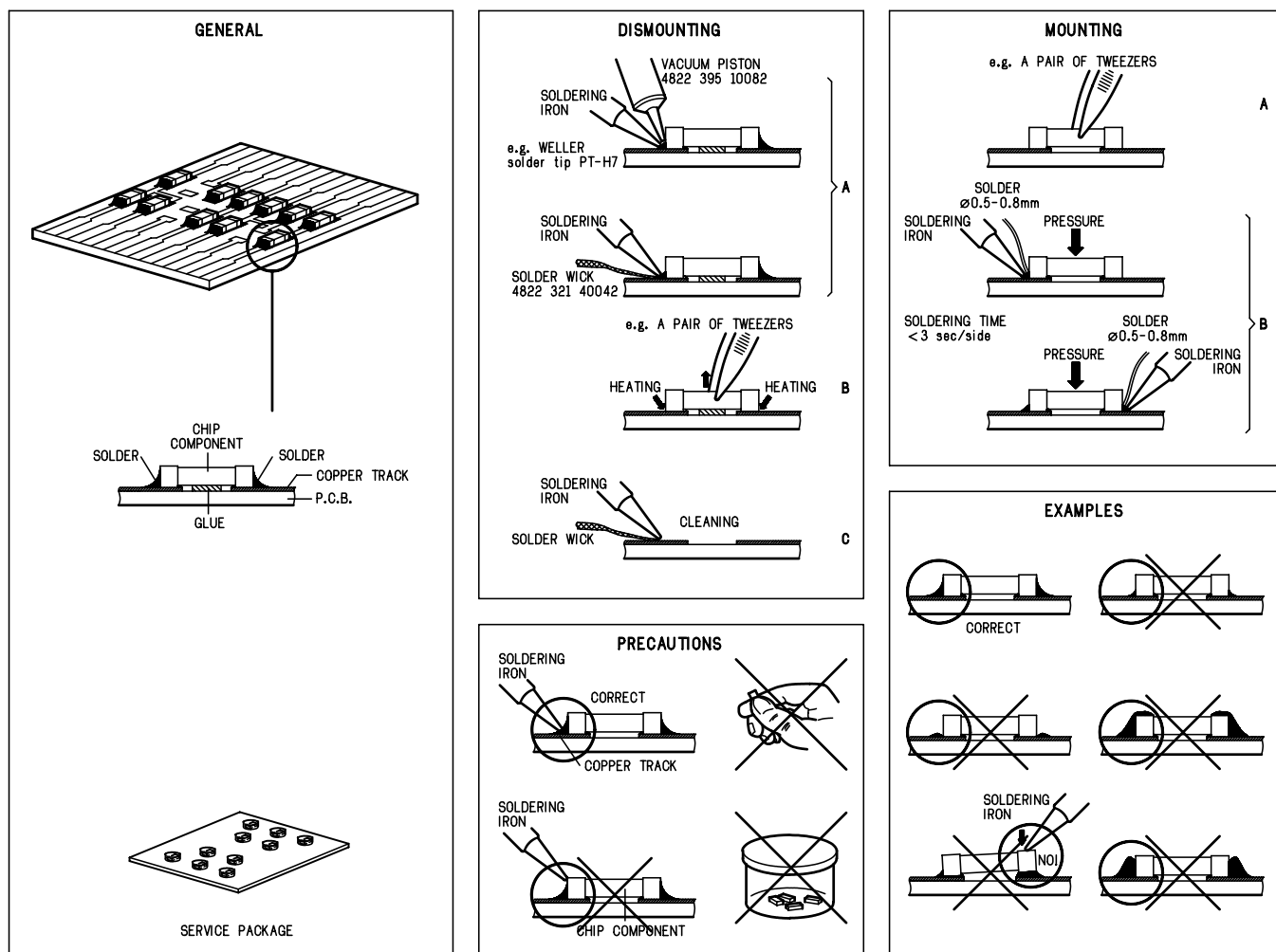

SERVICE TOOLS

Audio signal disc SBC429	4822 397 30184
Playability test disc SBC444	4822 397 30245
Test disc 5 (disc without errors) + Test disc 5A (disc with dropout errors black spots and fingerprints) SBC426/ SBC426A	4822 397 30096

ESD PROTECTION EQUIPMENT

Anti-static table mat large 1200x650x1.25mm	4822 466 10953
small 600x650x1.25mm	4822 466 10958
Anti-static wristband	4822 395 10223
Connection box (3press stud connections,1MΩ)	4822 320 11307
Extendible cable (2m,2MΩ ,to connect wristband to connection box)	4822 320 11305
Connecting cable (3m,2MΩ ,to connect table mat to connection box)	4822 320 11306
Earth cable (1MΩ , to connect any product to mat or to connection box)	4822 320 11308
KIT ESD3 (combining all 6 prior products - small table mat)	4822 310 10671
Wristband tester	4822 344 13999

SERVICE HINTS

REPAIR POSITION COPPERSIDE

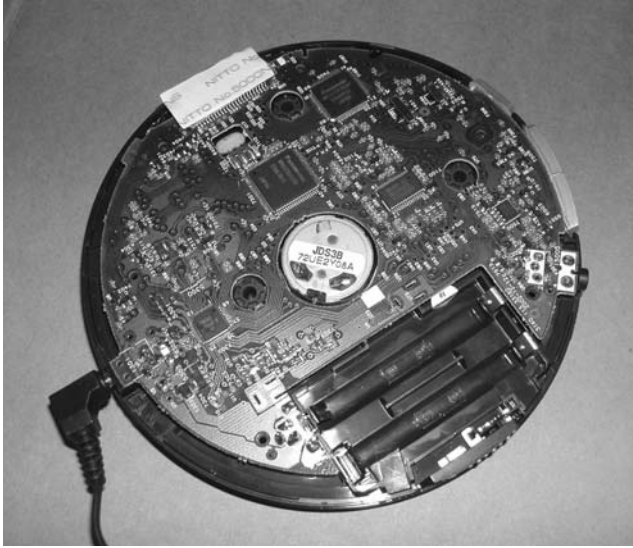

To get access to the copperside of the printed board assembly proceed as follows:

- 1.Remove the bottom (3x) screws (2x of them under the rubber-foot) and the up (2x) screws (in the CD-door)
- 2.Lift the bottom -cabinet
- 3.Supply the unit via external DC-socket
- 4.Take care that the door switch is closed during measurements

DISMANTLING THE CD-DOOR

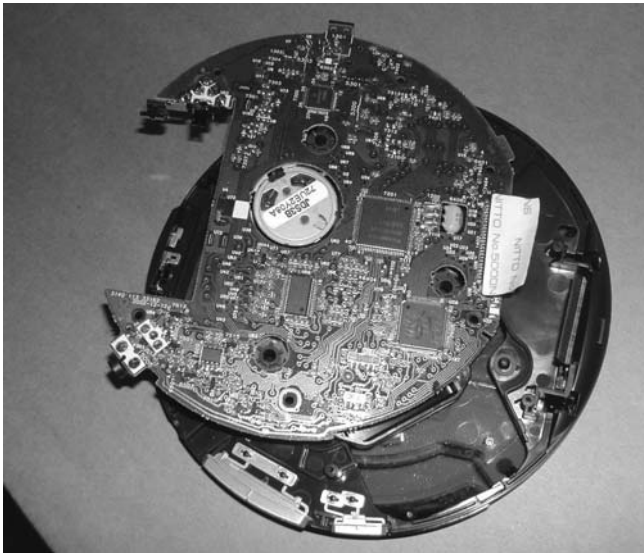

To dismantle the CD-door proceed as follows:

- 1.Dismantle bottom and printed board/drive assembly
- 2.Disconnect the sticker
(flex-foil connector on the membrane keyboard)
- 3.Disconnect membrane keyboard
(flex-foil connector on copperside of printed board)

REPAIR POSITION COMPONENTSIDE

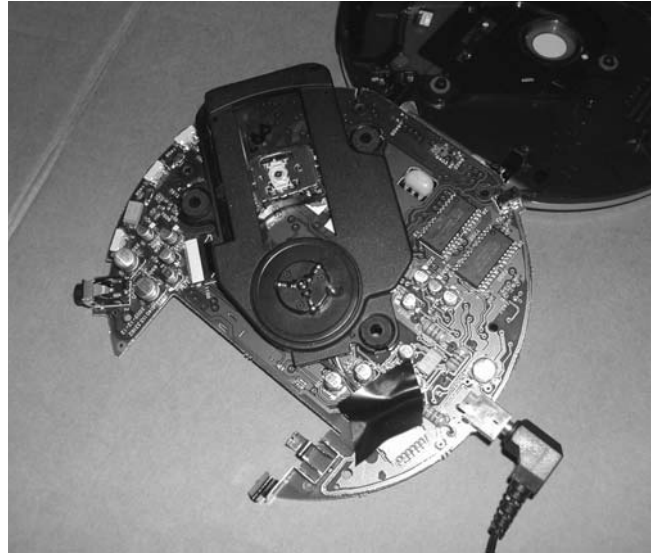

To get access to the componentside of the printed board assembly proceed as followed:

- 1.Remove the bottom (3x) screws (2x of them under the rubber-foot) and the up (2x) screws (in the CD-door)
- 2.Open the CD-door
- 3.Lift the top-cabinet and put it backwards on the table
- 4.Supply the unit via the external DC-socket
- 5.Take care that the door switch is closed during measurements

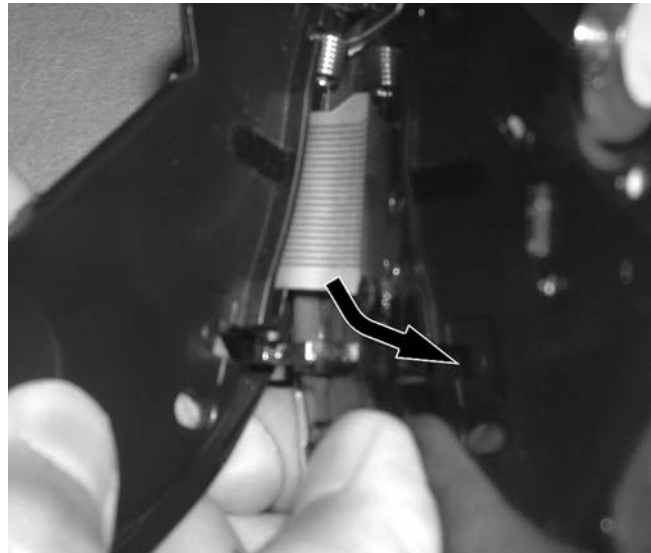

- 4.Bend the cabinet rightwards downwards as indicated in the picture above

Remark:Do not use screwdrivers or tools .
Sharp edges could damage hinge or cabinet part.

START-UP PROCEDURE -CHART

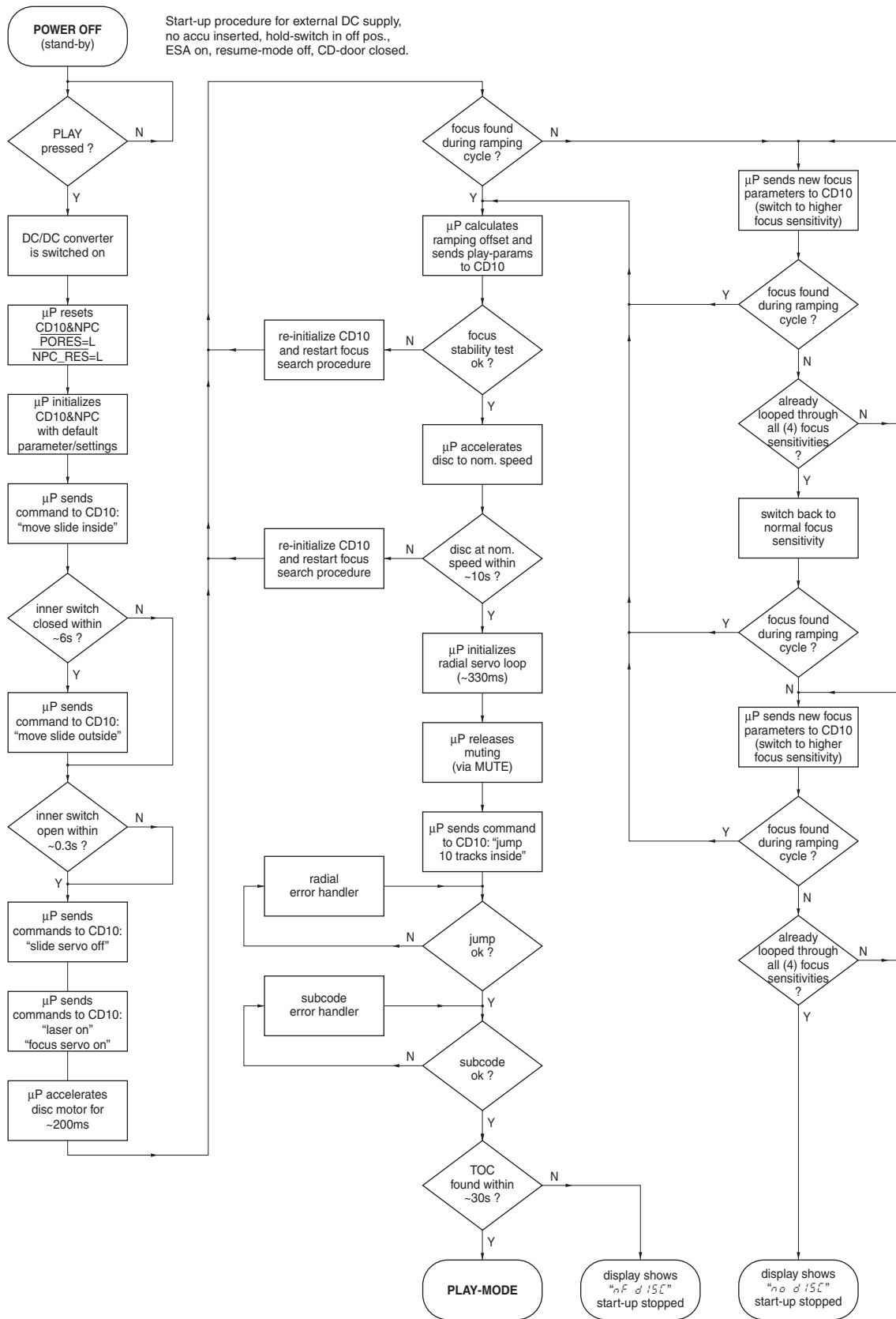

SERVICE TEST PROGRAM

1. PRELIMINARY SETUP

- To enter the service test program disconnect the AC/DC adaptor and remove batteries, open the CD-door and hold the buttons "PLAY" & "VOL+" depressed while turning power on (i.e. connecting the AC/DC adaptor).
- The display shows the software version of the built-in μP (i.e. "5 - 25"). Versions are counted from "22" onwards; that means the higher the number the newer the software.
- The program is now in the main menu – various tests can be entered by pressing the corresponding buttons (see flow chart on next page or detailed description of available tests below).
- To exit the service test program press the "STOP" button or disconnect the set from the power source.

2. DISPLAY TEST

Purpose: Check functionality of display and display driver.

- To enter the display test start the service test program and press the "NEXT" button.
- The display shows test pattern1. All segments are activated for finding open circuits (see flow chart on next page).
- To jump to the next pattern press the "NEXT" button.
- The display shows test pattern2. All alternate pins (2, 4, ...) are activated for finding short circuits (see flow chart on next page).
- To jump back to test pattern1 press the "NEXT" button, to exit the display test and return to the main menu press the "STOP" button.

3. KEY TEST

Purpose: Check operation of keys and cord remote control.

- To enter the key test start the service test program and press the "MODE" button.
- The display shows " - - ".
- Hold key depressed and check corresponding key code on the display. Key codes can be found in table1 (see flow chart on next page).
- To exit the key test and return to the main menu press the "STOP" button.

4. PLAYBACK TEST WITH ERROR ANALYSIS

Purpose: Analyze errors that occur during playback and search for intermittent failures.

- To enter the playback test start the service test program and press the "BASS" button.
- To start the error analysis press the "PLAY" button. Note that the playback test can only be entered if the CD-door is closed.
- The set will read the TOC and start playback.

As long as the playback is free of errors the display shows track and time information like in normal play-mode. In case of errors corresponding error codes will be displayed. The meaning of these error codes can be found in table2 (see flow chart on next page).

Note: Errors can either be "fatal" or "non fatal". Fatal errors always stop the playback, non fatal errors only cause a short interruption of the music. Fatal errors are displayed as long as the set is connected to the power source, non fatal errors are displayed until a new error occurs or a button is pressed.

- To stop the playback test disconnect the set from the power source.

5. SERVO TEST

Purpose: Check door switch, inner switch of CD-drive, movement of slide and acceleration of discmotor.

- To enter the servo test start the service test program and press the "PLAY" button.
- The display shows " $\overline{c} \overline{d} xy$ ".
"x" indicates state of door switch;
"y" indicates state of inner switch.
 $x, y = \overline{c}$ means switch is closed; " \overline{c} " means switch is open.
- To move slide outside hold the "NEXT" button depressed.
- To move slide inside hold the "PREV" button depressed.
- To accelerate the discmotor clockwise hold the "MODE" button depressed.
- To accelerate the discmotor counter-clockwise hold the "PROG" button depressed.
- To enter the focus test press the "PLAY" button, to exit the servo test and return to the main menu press the "STOP" button.

6. FOCUS TEST

Purpose: Check movement of lens and operation of focus servo for CDDA and CDRW discs.

Since the CDRW reflects much less light than an ordinary CDDA, the gain of the HF-amplifier stage and the sensitivity of the ADC inside the Decoder&Digital Servo IC "CD10" must be adapted accordingly. The gain is switched via the CDRW input of the HF-preamplifier. The ADC-sensitivity is set via software parameters (sent from μP to "CD10"). In total, there are 4 sensitivity modes available: 1 for CDDA and 3 for CDRW. The modes are listed in table3 (see next page). In normal play-mode, the correct focus sensitivity is chosen automatically during start-up (see "Start-up procedure" on previous page). In the service test program, the sensitivity can be chosen manually in order to allow individual measurements in several modes.

- The focus servo loop is switched on and the set starts searching the focus ("focus ramping"). As soon as the focus has been found the focus servo loop is closed and the state of the focus is monitored continuously.
- If the focus is OK the display shows " $F x$ ", else " $- F x$ ". "x" indicates the sensitivity mode. Details can be found in table3 (see flow chart on next page).
- To toggle between sensitivity modes press the "BASS" button.
- To move slide outside hold the "NEXT" button depressed.
- To move slide inside hold the "PREV" button depressed.
- To accelerate the discmotor clockwise hold the "MODE" button depressed.
- To accelerate the discmotor counter-clockwise hold the "PROG" button depressed.
- In case the focus is OK the discmotor test can be entered by pressing the "PLAY" button, to exit the focus test and return to the main menu press the "STOP" button.

7. DISCMOTOR TEST

Purpose: Check speed regulation of discmotor.

- The speed regulation is switched on and the discmotor starts rotating. If the speed reaches 75% of the nom. speed the display shows " d ", else " $-d$ ".
- In parallel also the state of the focus is monitored continuously (display " $F x$ " or " $- F x$ ").
- In case the disc speed is OK and the focus is OK the radial test can be entered by pressing the "PLAY" button, to exit the discmotor test and return to the main menu press the "STOP" button.

8. RADIAL TEST

Purpose: Check if radial loop locks and an audio signal is audible at the headphone output.

- The radial servo loop is switched on, mute is released and the audio signal is audible. If the system is on track the display shows " r ", else " $-r$ ".
- In parallel also the disc speed (display " d " or " $-d$ ") and the state of the focus (display " $F x$ " or " $- F x$ ") are monitored continuously. Note: In case of radial errors the audio output is muted and muting is not released automatically when the systems recovers from the error. " $-r$ " remains on the display.
To open mute again press the "NEXT" or "PREV" button.
- To jump 16 tracks outside press the "NEXT" button.
- To jump 16 tracks inside press the "PREV" button.
- To exit the radial test and return to the main menu press the "STOP" button, to exit the service test program disconnect the set from the power source.

Important remark:

In radial test mode data to the DRAM is written at 1.2 times the nominal speed, and read from the DRAM at nominal speed. Because writing is done faster than reading the DRAM gets full after a certain time. In normal play mode the system would now wait until the DRAM is partly emptied again, jump backwards and resume filling at the last written position. However, in radial test mode the jumps would disturb measurements on the radial servo loop. Therefore this function has been disabled and filling restarts immediately from the current position of the pick-up unit. As a result "jumps" are audible during playback.

SERVICE TEST PROGRAM - FLOW CHART

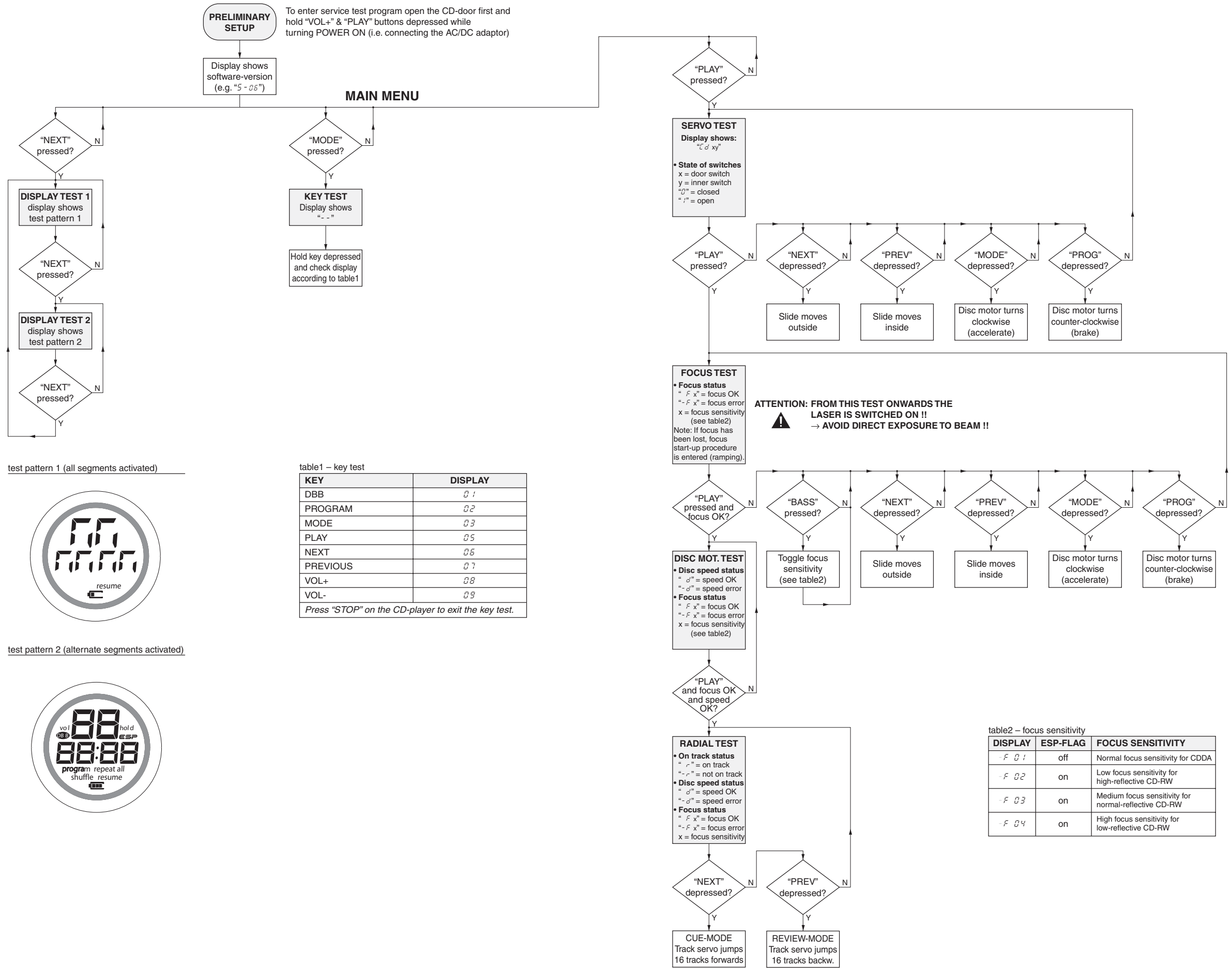

test pattern 1 (all segments activated)



test pattern 2 (alternate segments activated)



table1 - key test

KEY	DISPLAY
DBB	01
PROGRAM	02
MODE	03
PLAY	05
NEXT	06
PREVIOUS	07
VOL+	08
VOL-	09

Press "STOP" on the CD-player to exit the key test.

table2 - focus sensitivity

DISPLAY	ESP-FLAG	FOCUS SENSITIVITY
-F 01	off	Normal focus sensitivity for CDDA
-F 02	on	Low focus sensitivity for high-reflective CD-RW
-F 03	on	Medium focus sensitivity for normal-reflective CD-RW
-F 04	on	High focus sensitivity for low-reflective CD-RW

BLOCKDIAGRAM

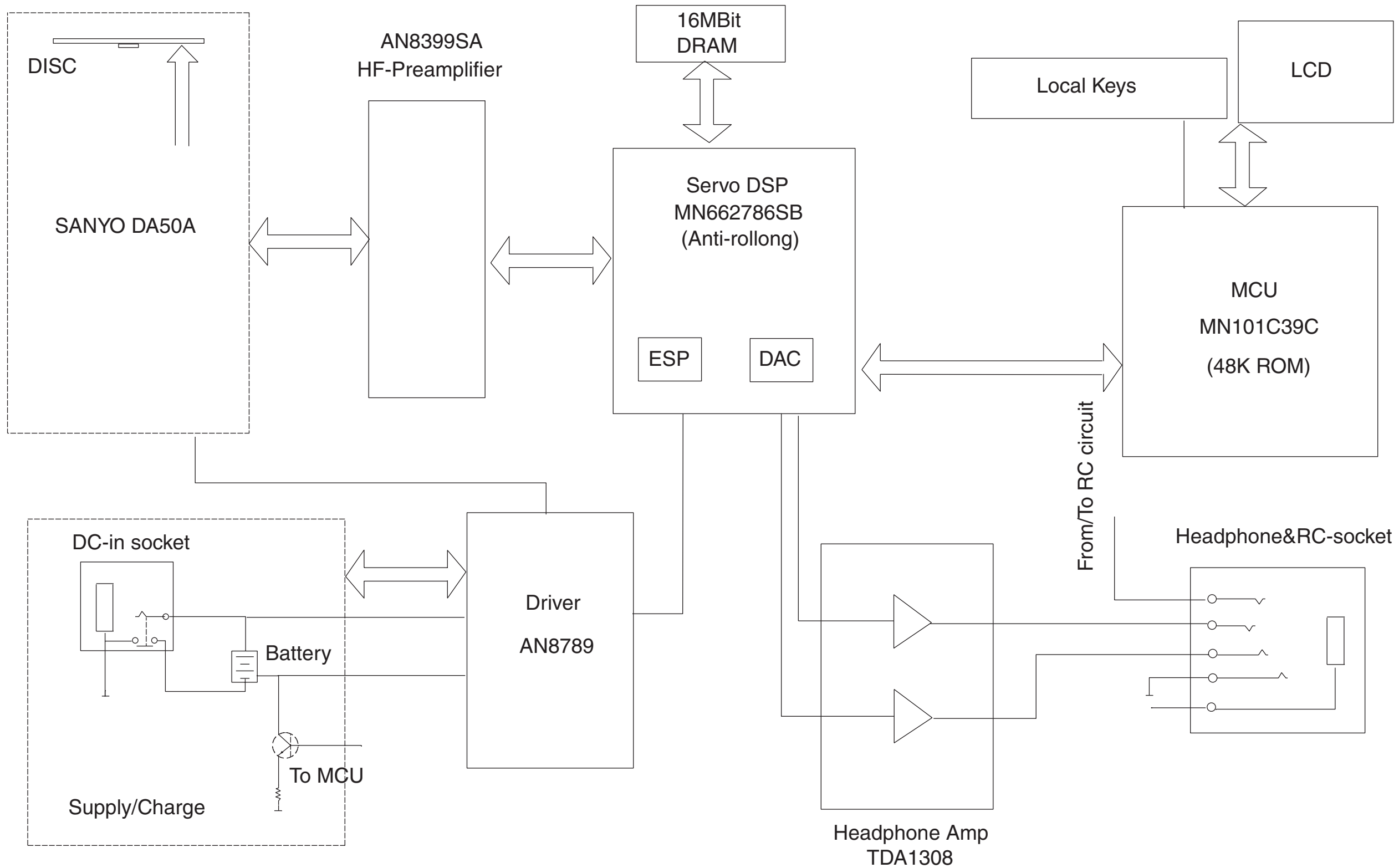

CIRCUIT DIAGRAM - CONTROL / SUPPLY PART

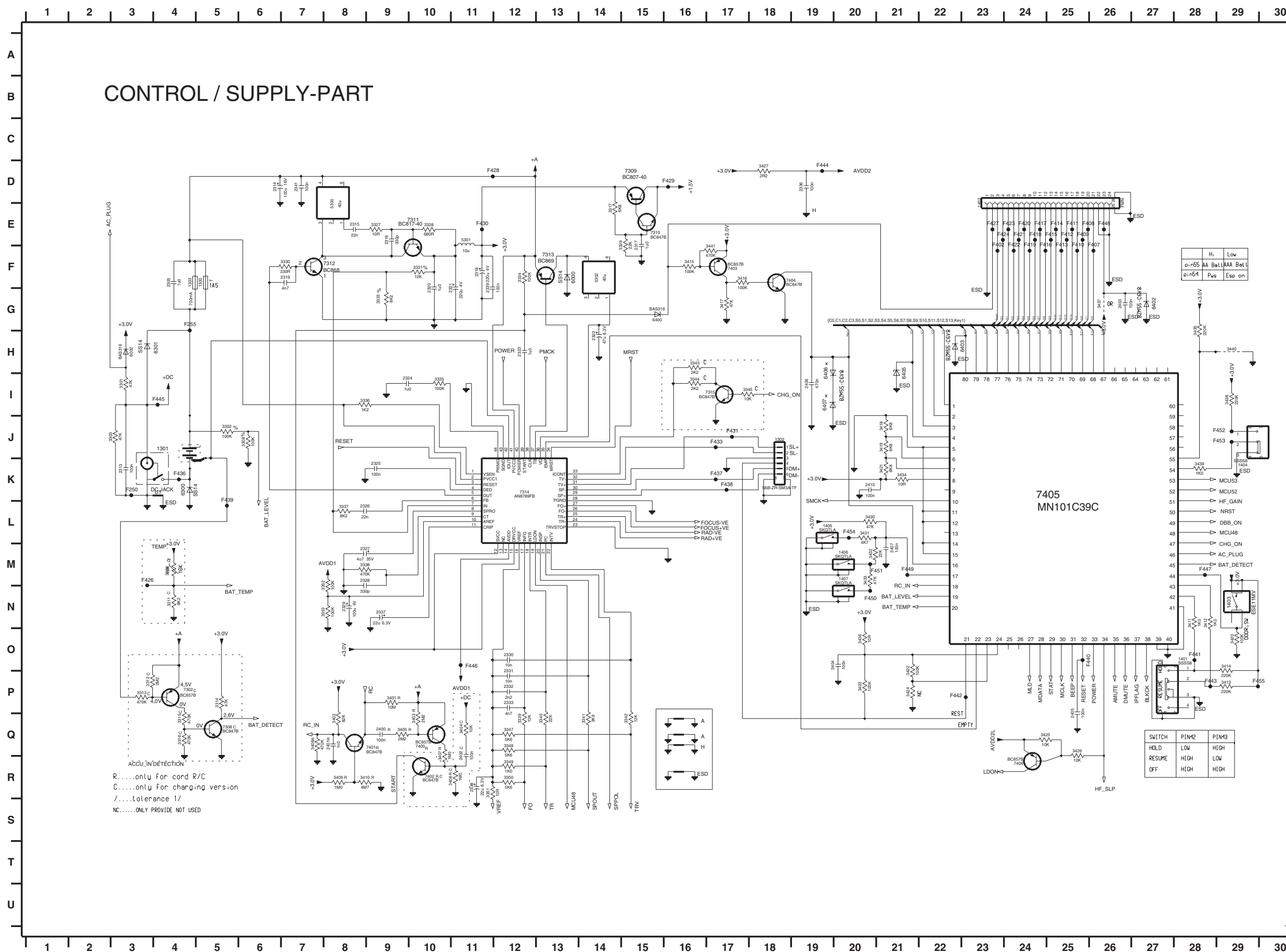

- U1 K4
- 1300 F5
- 1301 J4
- 1302 J18
- 1303 F4
- 1401 O28
- 1402 D23
- 1403 N29
- 1404 K29
- 1405 L19
- 1406 M20
- 1407 M20
- 2305 F4
- 2313 K3
- 2314 D6
- 2315 E8
- 2316 E9
- 2317 E15
- 2318 F11
- 2319 F7
- 2320 F10
- 2321 F11
- 2322 H14
- 2323 H12
- 2324 I9
- 2325 K9
- 2328 M8
- 2329 N8
- 2330 O12
- 2331 P12
- 2332 P12
- 2333 P12
- 2336 D19
- 2337 N9
- 2338 R11
- 2339 F11
- 2341 D7
- 2400 Q9
- 2401 Q8
- 2402 Q11
- 2403 G26
- 2404 O20
- 2405 P25
- 2406 I19
- 2407 M21
- 2410 K20
- 3301 I3
- 3302 J5
- 3303 J3
- 3308 J6
- 3309 M4
- 3311 N4
- 3312 P3
- 3313 P3
- 3314 P5
- 3315 Q4
- 3316 Q4
- 3317 E14
- 3327 E9
- 3328 E10
- 3329 E15
- 3330 F7
- 3331 F10
- 3333 G9
- 3334 F12
- 3335 I10
- 3336 I8
- 3337 L8
- 3338 M8
- 3339 Q12
- 3341 Q14
- 3342 Q15
- 3343 H16
- 3344 I16
- 3345 I17
- 3347 Q12
- 3348 Q12
- 3349 R12
- 3350 R12
- 3351 R11
- 3352 M8
- 3353 N8
- 3401 P9
- 3402 Q8
- 3403 Q10
- 3404 Q11
- 3405 Q9
- 3406 Q7
- 3407 Q10
- 3408 R11
- 3409 R8
- 3410 R8
- 3411 N28
- 3412 N28
- 3413 P29
- 3414 O29
- 3415 F16
- 3416 F17
- 3417 G17
- 3418 J21
- 3419 J21
- 3420 O29
- 3421 K21
- 3422 O21
- 3423 P20
- 3424 P21
- 3425 O24
- 3426 O25
- 3427 D18
- 3430 L20
- 3431 L20
- 3432 M20
- 3433 M20
- 3434 K21
- 3435 G28
- 3436 O20
- 3437 G28
- 3438 I29
- 3439 K28
- 3440 H29
- 3441 F17
- 5300 E8
- 5301 E11
- 5302 F14
- 6000 F13
- 6002 H3
- 6300 K4
- 6301 H4
- 6400 G15
- 6402 G27
- 6403 H22
- 6405 H21
- 6406 H19
- 6407 I19
- 7302 P4
- 7308 Q5
- 7309 D15
- 7310 E15
- 7311 E9
- 7312 F7
- 7313 F13
- 7314 K12
- 7315 I17
- 7400 G10
- 7401 D8
- 7402 R10
- 7403 F17
- 7404 F18
- 7405 K24
- 7406 R24
- F250 K3
- F255 G4
- F402 F23
- F407 F26
- F408 E25
- F409 E25
- F410 F25
- F411 E25
- F412 E25
- F413 F25
- F414 E25
- F415 E25
- F416 F24
- F417 E24
- F420 E24
- F421 E24
- F422 F24
- F423 E24
- F424 E23
- F425 M3
- F427 E23
- F428 D11
- F429 D16
- F430 E11
- F431 J17
- F433 J17
- F436 K4
- F437 K17
- F438 K17
- F439 L5
- F440 O25
- F441 O28
- F442 P22
- F443 P28
- F444 D19
- F445 I4
- F446 O11
- F447 M29
- F448 E26
- F449 M21
- F450 N20
- F451 M21
- F452 J29
- F453 J29
- F454 L20
- F455 P29

CIRCUIT DIAGRAM - DRIVE/ESP PART

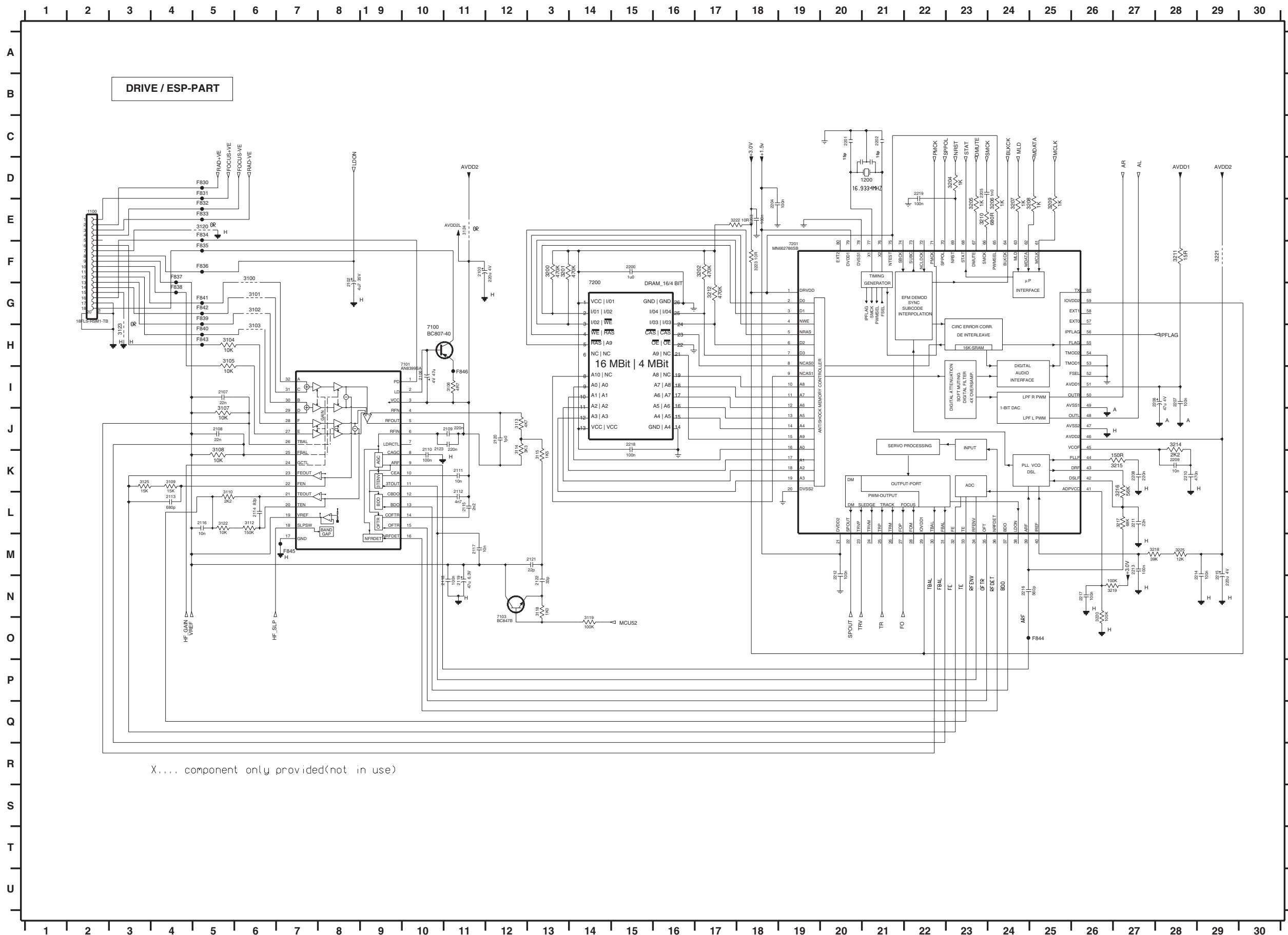

DRIVE / ESP-PART

X... component only provided(not in use)

- 1100 E2
- 1200 D21
- 2100 F1
- 2102 F8
- 2106 I10
- 2107 I5
- 2108 J5
- 2109 J11
- 2110 K10
- 2111 K11
- 2112 L11
- 2113 L4
- 2114 L6
- 2115 L11
- 2116 L5
- 2117 M11
- 2118 M11
- 2119 N11
- 2120 J12
- 2121 M13
- 2122 N13
- 2123 K10
- 2200 F15
- 2201 C20
- 2202 C21
- 2203 F18
- 2204 E18
- 2205 D23
- 2206 I28
- 2207 I28
- 2208 K27
- 2209 K28
- 2210 K28
- 2211 L27
- 2212 M20
- 2213 M27
- 2214 M29
- 2215 M29
- 2216 N24
- 2217 N25
- 2218 J15
- 2219 D22
- 3100 F6
- 3101 G6
- 3102 G6
- 3103 H6
- 3104 H5
- 3105 H5
- 3106 H11
- 3107 J5
- 3108 K5
- 3109 K4
- 3110 L5
- 3112 L6
- 3113 J12
- 3114 J12
- 3115 K19
- 3118 N13
- 3119 O14
- 3120 E5
- 3122 L5
- 3123 H3
- 3124 E11
- 3200 F13
- 3201 F13
- 3202 F13
- 3204 D23
- 3205 E23
- 3206 E24
- 3207 E24
- 3208 E25
- 3209 E25
- 3210 E23
- 3211 F28
- 3212 G17
- 3214 J28
- 3215 K27
- 3216 K27
- 3217 L27
- 3218 M27
- 3219 N26
- 3220 N26
- 3221 F29
- 3222 E17
- 3223 F18
- 3225 M28
- 7100 H10
- 7101 H9
- 7103 O12
- 7200 G14
- 7201 F19
- F830 D5
- F831 D5
- F832 E5
- F833 E5
- F834 E5
- F835 F5
- F836 F5
- F837 F4
- F838 G4
- F839 G5
- F840 H5
- F841 G5
- F842 G5
- F843 H5
- F844 O25
- F845 M7
- F846 H11

EXPLODED VIEW DIAGRAM

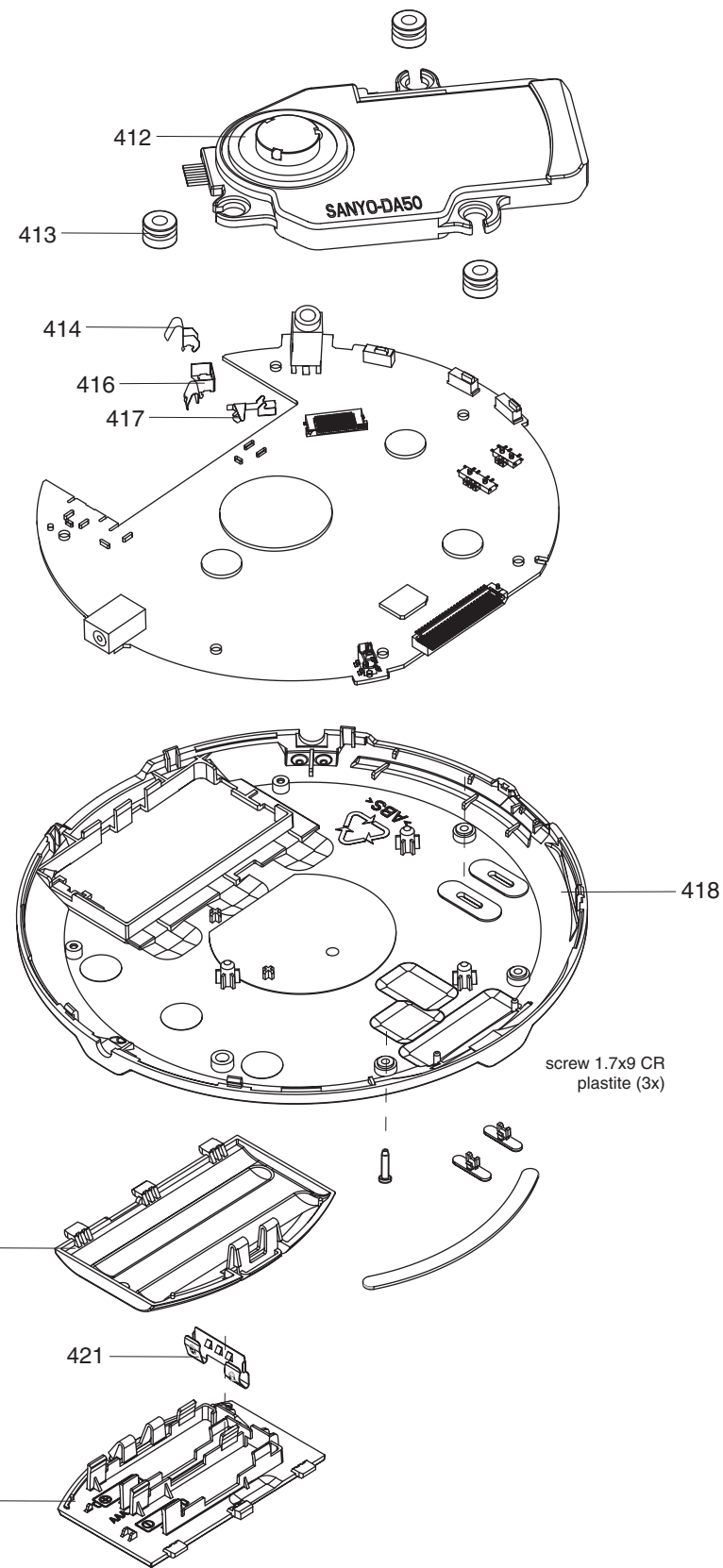
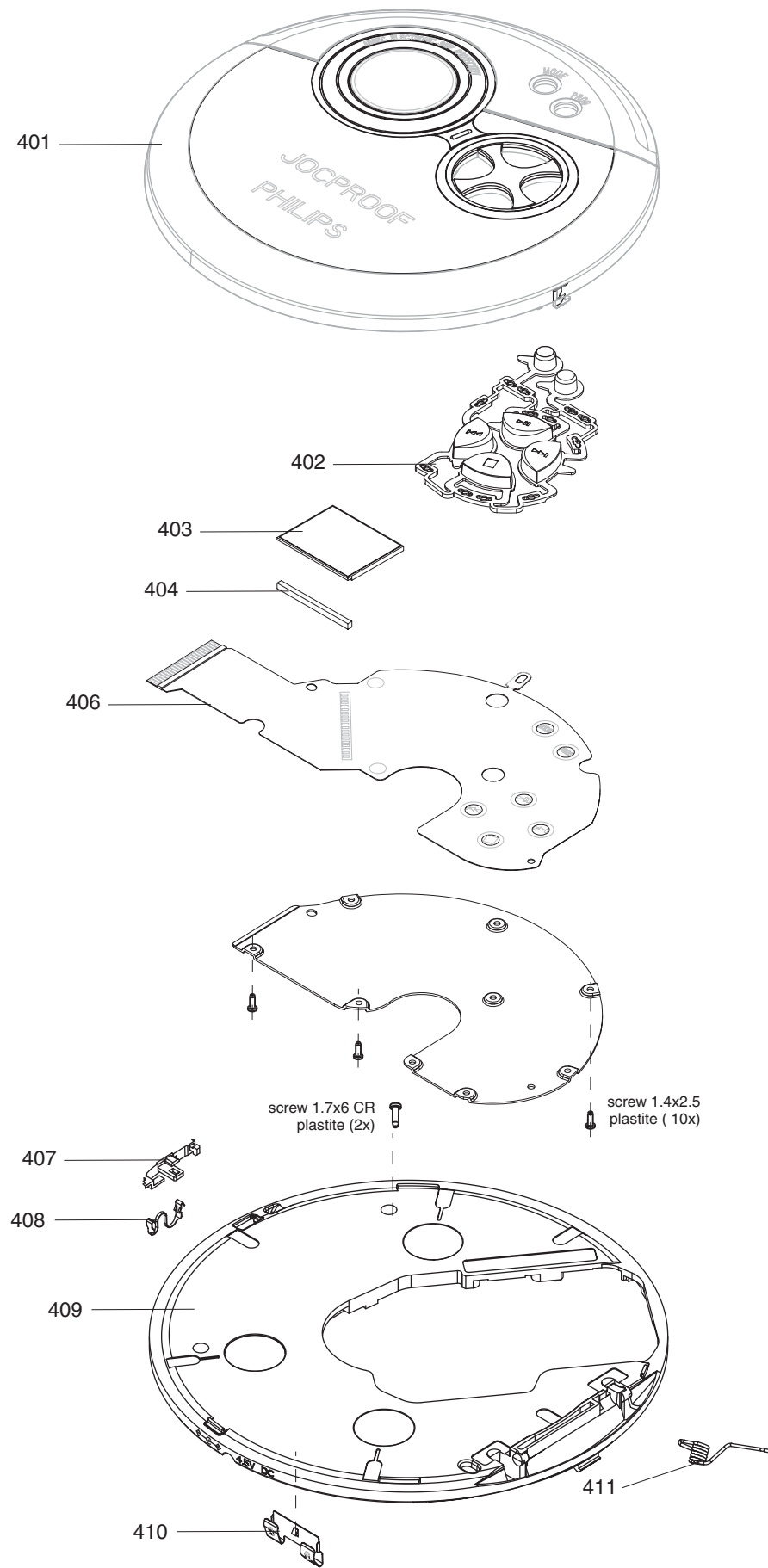

MECHANICAL PARTSLIST - CABINET

401	3140 117 72271	CD DOOR ASSY AX3301/AX3306 (silver)
401	3140 117 70181	CD DOOR ASSY AX3300/AX3303/AX3305/AX3311(blue)
401	3140 117 72351	CD DOOR ASSY AX3312 (red)
401	3140 117 72371	CD DOOR ASSY AX3315 (purple)
402	3140 117 70171	KEY SET PNT
403	3140 110 52011	LCD
404	3140 114 62241	ZEBRA STRIP
406	3140 113 33461	MEMBRANE-ETERNITY
407	3140 117 71921	SLIDER-DOOR-OPEN
408	3140 111 22611	SPRING-SLIDER-OPEN
409	3140 117 71901	MIDDLE-CABINET-ASSY
410	3140 111 22621	SPRING BATTERY-SET +/-
411	3140 111 23231	CD DOOR SPRING
412	2422 549 45374	CD DRIVE DA50
413	3140 114 61761	DAMPER
414	3140 111 22581	SPRING BATTERY, -VE
416	3140 111 22571	SPRING BATTERY, +VE
417	3140 111 22600	SPRING BATTERY CHARGE
418	3140 117 71611	BOTTOM ASSY
419	3140 117 72151	DOOR-BATTERY-2A
421	3140 111 22631	SPRING BATTERY-DOOR +/-
422	3140 117 71631	DOOR-BATT-3A-ASSY

Note: Only these parts mentioned in the list are normal service parts.

ELECTRICAL PARTSLIST

- MISCELLANEOUS -

1000	3140 118 03261	PBAS 8 MAINPB AX3300/AX3301/AX3305/AX3306
1000	3140 118 03271	PBAS 8 MAINPB AX3303
1000	3140 118 03281	PBAS 8 MAINPB AX3311/AX3312/AX3315
1300	2422 086 11112	FUSE 1,5A 125V
1301	2422 026 05086	CONNECTOR SUPPLY H 1P
1401	2422 127 00547	SWITCH-SLID
1403	2422 129 16818	SWITCH-DET
1404	2422 127 00543	SWITCH-SLID
1405	2422 128 02968	SWITCH-TACT
1406	2422 128 02968	SWITCH-TACT
1407	2422 128 02968	SWITCH-TACT
1500	2422 026 05204	SOCKET PHONE H 1P
5300	2422 549 45827	IND VAR 5MM 5T 2MHZ52 Y
5302	2422 549 45827	IND VAR 5MM 5T 2MHZ52 Y

Note: Only these parts mentioned in the list are normal service parts.